

TruSABER w/ SideArm

Description

Exposed chrome plated flush valve for 3/4" top spud urinals with TruStop control stop and side mounted sensor activated actuator ("SideArm")

Flush Cycle

0.5 gpf / 1.9 Lpf High Efficiency

Specification

- SideArm (side mounted sensor actuator)
- Regulating screw for "True-in-the-Field" water conservation.
- Mashaerator self-cleaning bypass diaphragm
- 3/4" Vandal proof TruStop ball valve designed angle control stop with TruChek.
- Sweat adapter kit
- Renewable main valve seat
- ADA compliant metal "Rubberflex" oscillating handle.
- Slip-Joint adjustable tailpiece
- 3/4" x 9" vacuum breaker flush connection
- Wall flange, spud nut and spud flange for 3/4" top spud
- All rubber parts molded of chloramine resistant rubber

Variations

- AM - Antimicrobial Coated Handle
- SH - SmartHandle Dual-Flush with Antimicrobial Coating
- T36 - Solid ring wall support for flush connection
- Logo - Customized Cover Cap w/ Logo

Valve is certified to be in compliance to the applicable sections of ASSE 1037 and ANSI/ASME 112.19.2 WaterSense Listed and compliant when paired with a WaterSense compliant fixture.

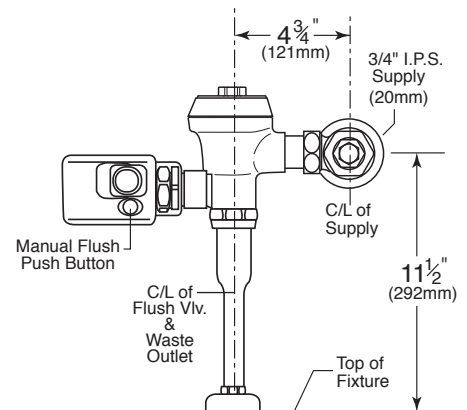

ASSE 1037

